

Swimming Pool and Spa Purification System

Pool Pilot™

Digital

by AUTOPILOT SYSTEMS INC.

DIG-220

Owners Manual

Installation and Operation

(For Indoor or Outdoor Use)

Pool Owner, save this manual for reference.
Installer, leave this manual with the Pool Owner.

IMPORTANT

Read This Manual Before Installing & Operating

#18500-DIG R9A 5/2007

Pool Pilot™

Digital

by AUTOPILOT SYSTEMS INC.

Record The Following Information

Installer: _____	Date of Installation: _____
Control Unit Model Number: <u>DG-220</u>	Control Unit Serial Number: # _____
Cell Model Number: <u>SC-</u>	Cell Serial Number: # _____

Factory Direct Customer Assistance...

HOTLINE: 1.800.922.6246 or 1.954.772.2255

FAX: 1.954.772.4070

[e-mail to: AutoPilotTechSupport@teamhorner.com](mailto:AutoPilotTechSupport@teamhorner.com)

Visit Us On The Internet @

<http://www.autopilot.com>

Manufactured by

Aqua Cal AutoPilot Inc.

2737 24th Street North • St Petersburg • Florida 33713, U.S.A.

Pool Pilot™

Digital

by Aqua Cal AutoPilot Inc.

Section 1b – GENERAL PRODUCT INFORMATION



IMPORTANT SAFETY INSTRUCTIONS

READ AND FOLLOW ALL INSTRUCTIONS

INSTALLATION AND EQUIPMENT RELATED

Installation of all **Pool Pilot™ Digital** models:

Follow all National Electric Codes (NEC) unless State or Local guidelines supersedes. When installing and using your **Pool Pilot™ Digital** Control Box, basic safety precautions must always be followed, including the following:

1.  **DANGER** – Risk of electrical shock. To avoid serious injury or death,
 - Ensure that the electrical panel or filter pump circuit is turned OFF prior to installation or servicing inside any Autopilot unit.
 - Mount the Control Box to ensure the least amount of direct exposure to rain, garden sprinkler water, direct sunlight, or any corrosive environment.
 - Install the Control Box at least 10' (3 m) for 115VAC Units, from the inside wall of the pool or spa using non-metallic plumbing. 5' (1.5 m) minimum distance for 230VAC Units.
2.  **DANGER** – To avoid serious injury or death, do not permit children to use this product unless they are closely supervised at all times. Children should not use spas, hot tubs, or pools without permanent adult supervision.
3.  **WARNING** – To avoid personal injury, maintain water chemistry in accordance with manufacturer's instructions.
4. All field-installed metal components such as rails, ladders, drains, or similar hardware within 10' (3 m) of the spa or hot tub shall be bonded to the equipment grounding bus with copper conductors not smaller than No. 8 AWG (8.4 mm²).

Equipment Related

115/230VAC, 50/60 Hz Models (fixed wiring)

- 1 A wire connector is provided on your **Pool Pilot™ Digital** to connect a minimum No. 8 AWG (8.4 mm²) solid copper bonding conductor between this unit and any metal equipment, metal enclosures of electrical equipment, metal water pipe or conduit within 5' (1.5 m) of the unit.
- 2 A bonding terminal is located inside your **Pool Pilot™ Digital**. To reduce the risk of electrical shock, this terminal must be connected to the grounding means provided in the electrical supply panel with a continuous copper wire equivalent size to the circuit conductors supplying your **Pool Pilot™ Digital**.
- 3 A disconnection device from the power source, with a contact separation of at least 0.12" (3mm) in all poles, must be incorporated in the fixed wiring for permanently wired units.
- 4 The input voltage to the **Pool Pilot™ Digital** must match the 115/230VAC jumper terminals on the Circuit board, marked "TRANSFORMER PRIMARY", shown on Page 5.
- 5 The Control Box is provided with (3) knock out holes for electrical conduit connections and has (1) 1/2" Liquidtite fitting already attached. 1/2" non-metallic flex conduit is recommended.

SAVE THESE INSTRUCTIONS

Table of Contents

Pool Pilot™

Digital

by Aqua Cal AutoPilot Inc.

Section 1 GENERAL PRODUCT INFORMATION

1a	Product Information and Contact Numbers	1
1b	Important Safety Instructions	2
1c	Table of Contents	3

Section 2 INSTALLATION

2a	Main Components	4
	Control Box Installation	4
	Electrical Connections	
	Cell Cord and Tri-Sensor Connections	
	ORP Connections	
2b	Cell and Manifold Installation	6
	Verification of Flow Switch Protection	6

Section 3 OPERATION

3a	Key Features – Display Panel	7-9
3b	Pool Water Preparation	10
	Salt Requirement Chart	
	Start-Up Procedures	
3c	Monitoring and Maintenance	11
	Water Chemistry Parameters	
	Saturation Index	

Section 4 SERVICE and MAINTENANCE

4a	Control Box and Fuse Locations	12
	Tri-Sensor Assembly	12
4b	Cell	13
	Removal and Inspection	
	Maintenance and Cleaning	
	Filter Backwashing	13
4c	Parts Explosion	14

Section 5 TROUBLESHOOTING

5a	Troubleshooting	15
----	-----------------------	----

Section 2a – INSTALLATION

Main Components

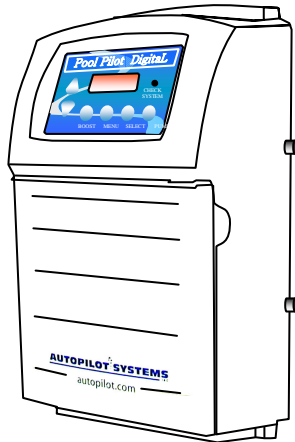

Control Box

converts incoming AC power to a Low Voltage DC current, which energizes the Cell(s).

Tri-Sensor Assembly

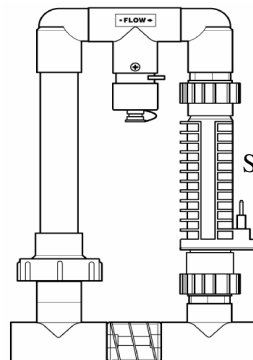

Maximum Operating Pressure: 50 psi
Maximum Flow Rate: 100 gpm

Patented Automatic Flow Bypass Manifold Assembly

ELECTROLYTIC SUPERCELL

receives Low Voltage DC current from the Power Circuit Board, which initiates the electrolytic process.

TRI-SENSOR ASSEMBLY

ensures that adequate **Flow**, **Salt Level**, and **Water Temperatures** are satisfactory to prevent abusive conditions for the cell to operate.

SPECIFICATION RATINGS:

Input Power: 115 VAC (3.0 AC amps)
230 VAC (1.5 AC amps)
50/60 Hz

Maximum daily

Cl₂ Output Rating: SC-60 1.92 lbs/day (0.88 kg/day)
@ Cell Power 3 SC-48 1.56 lbs/day (0.71 kg/day)
(8 amps DC) SC-36 1.28 lbs/day (0.58 kg/day)

Output Power: Cell Power 1 (5.0* DC amps)
Cell Power 2 (6.5* DC amps)
Cell Power 3 (8.0* DC amps)

Agency Approvals: NSF, ETL_{US}, ETL_C, CE

Internal Pump Relay is rated for 30-amp max.

*Indicates nominal amperage output. The dual axis controller will slightly vary the amps to optimize the power to the cell.

12' (3.6 m) of **Cell and Tri-Sensor cords** are provided with the unit. Ensure that the manifold is located within that distance from the control box with enough slack to allow for removal for service or maintenance.

The Digital display provides full information and diagnostics for maintenance and operation of your system. The programmable settings are retained on a microprocessor chip with the clock setting backed-up with a CR-2025 lithium battery.

CAUTION: To avoid over-saturation conditions of your spa, it is suggested to locate the cell downstream of all other equipment and on the pool return line only. For applications other than as recommended, contact the factory.

CONTROL BOX INSTALLATION

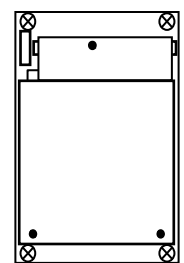
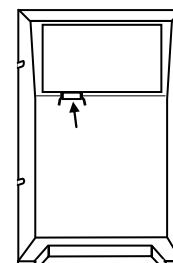
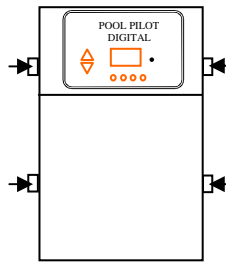
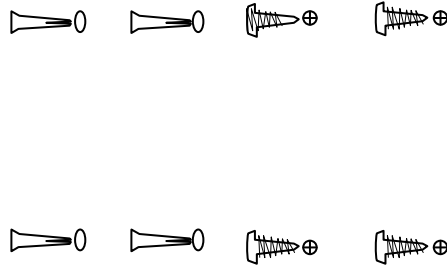
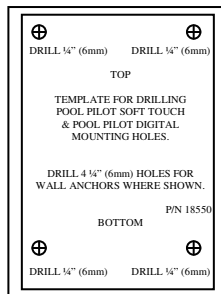

Place Template on mounting location. Level, mark holes and drill.

Use the (4) provided plastic anchors and insert into drilled holes.

Attach the (4) provided screws, leaving a 1/4" gap.

Loosen four fastening screws and lift off cover.

Disconnect wire harness.

Mount the Control Box and tighten the (4) mounting screws.

Section 2a – INSTALLATION

Control Box Connections

Electrical Connections (Follow all state/local codes for electrical installations)

Autopilot recommends that a licensed electrician or certified electrical contractor perform the electrical connections.

⚠ DANGER: ensure that the electrical panel or filter pump circuit breaker is turned OFF before wiring this unit. Units are pre-wired for the factory for 230VAC. Short test leads are attached to the AC terminal strip and must be removed prior to installation. You must provide the appropriate gauge wire for complete installations to the external timer, for **One-Speed Pump, or Two-Speed Pump** connections.

Converting from 230 VAC to 115VAC: Remove the cover (see page 12) to access the circuit board. Rewire and attach the included *jumper as shown below on the circuit board marked “TRANSFORMER PRIMARY”.

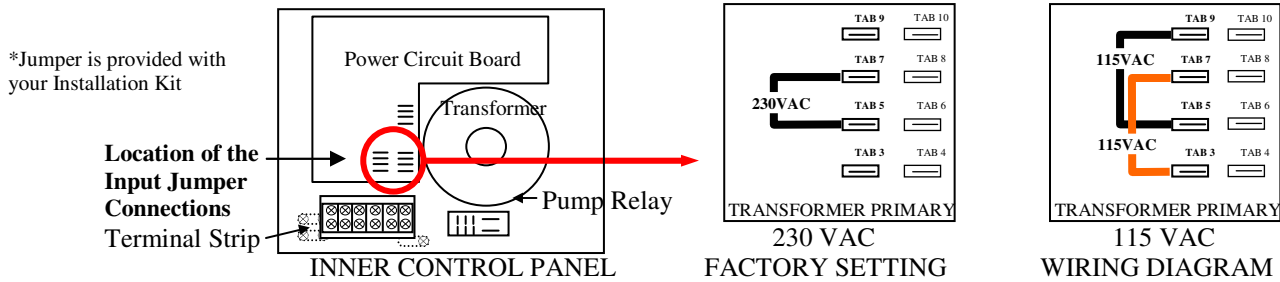

AC LINE IN (Wiring diagram also located on inside of cover): select the diagram that matches your application.

For 230 VAC; Brown (Br) = Line 1, Blue (Bl) = Line 2, Green w/Yellow Tracer (Gr/Yel) = Earth Ground

For 115 VAC; Brown (Br) = Line, Blue (Bl) = Neutral, Green w/Yellow tracer (Gr/Yel) = Earth Ground

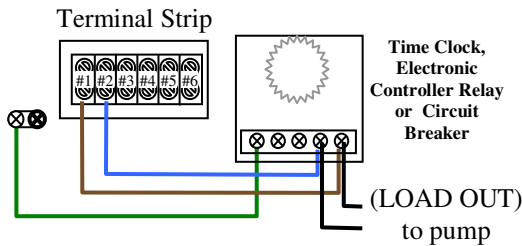

Connecting Pool Pilot to External Timer Setting:

Connect Factory AC wires to the **LOAD SIDE** or the same location as the circulation pump wires (pump connected to circuit breaker, time clock or electronic controller).

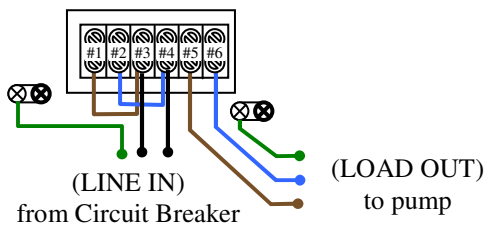

Connecting Pool Pilot to One-Speed Pump

LINE-IN: Discard Factory ground (Green) wire. Cut Factory AC wires to 5", strip and expose 1/2" of wire and connect from Terminal #1 to #3, and terminal #2 to #4. Supply **new** LINE-IN wires from Circuit breaker to Terminals #3 and #4. Ensure proper gauge wire is used to power the pump.

LINE-OUT: Pump is connected to Terminals #5, #6 and Ground lug.

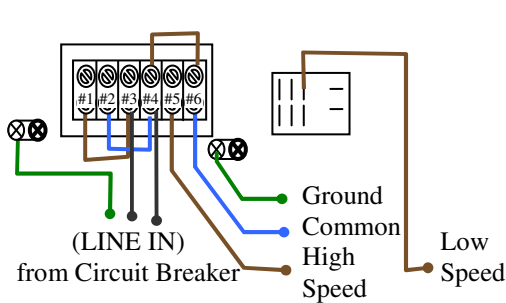

Connecting Pool Pilot to Two-Speed Pump

Follow instructions for One-Speed Pump **LINE-IN** configuration. Note: The pump is always powered. A safety shut off (wall switch) between the circuit breaker and control box is recommended when the circuit breaker cannot be accessed quickly

LINE-OUT:

- 1) Remove Factory #4 wire from Relay and Factory #6 wire from Terminal Strip. Cut wire in half, strip back jacket and expose 1/2" of wire, then jump to #6 Terminal strip.
- 2) Move #6 wire from Relay bottom row to the right top terminal and connect to the Low Speed of pump.
- 3) High Speed = Terminal #5, Common = Terminal #6.

Section 2b – INSTALLATION

Cell and Manifold Installation

Your Pool Pilot System is adaptable for use with either the SC-36, SC-48 or SC-60 residential cell. All models come pre-assembled with a Patented Automatic Flow Bypass Manifold Assembly. The manifold must be located as the **last component** in the **POOL RETURN LINE** only. For pool/spa combinations or special plumbing configurations, please contact the factory for assistance in locating the manifold.

Cell and Tri-Sensor Cord Connections

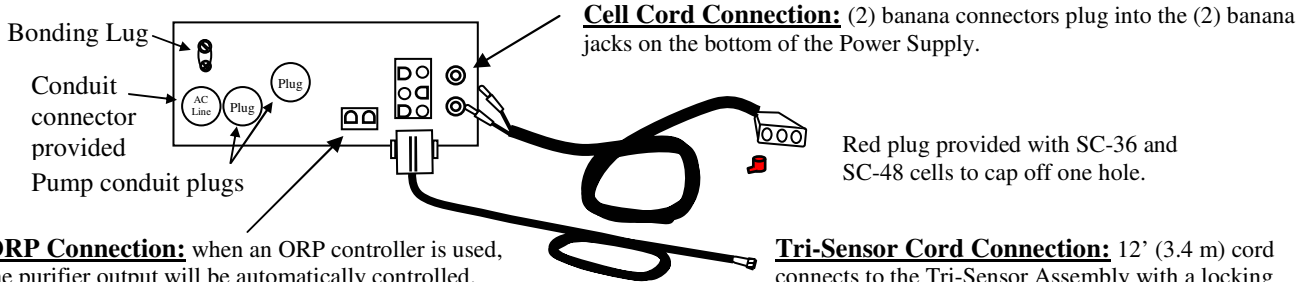

ORP Connection: when an ORP controller is used, the purifier output will be automatically controlled. Adjust the output level to 0% and connect the ORP controller to the 2-pin connector on the Control Box Base Plate. Although the output will displaying 0% output, the Pool Pilot will generate purifier as determined by the ORP controller.

Tri-Sensor Cord Connection: 12' (3.4 m) cord connects to the Tri-Sensor Assembly with a locking connector. Align the groove and keyway (also aligns to directional flow arrow on the Tri-Sensor) on the connector and twist the locking ring to ensure a proper connection. Refer to the instructions on pages 12 & 14 for diagrams and additional instructions.

⚠ WARNING: TO AVOID DAMAGE TO THE CONTROL BOX AND VOIDING THE WARRANTY, DO NOT ENERGIZE THE ORP INPUTS! THE ORP CONNECTIONS ARE DRY CONTACT INPUTS.

Standard Manifold Assembly (all models):

⚠ WARNING: Do not mount the manifold upside down.

Maximum flow rate 100 gpm (22.6 m³/hr). We recommend using a 3 lb spring bypass check valve for flow rates greater than 100 gpm (22.6 m³/hr) and plumbing it parallel to the manifold.

*One set of 68mm x 2" metric adapters (#19059) included with European Systems. For other plumbing configurations, please contact the factory for assistance.

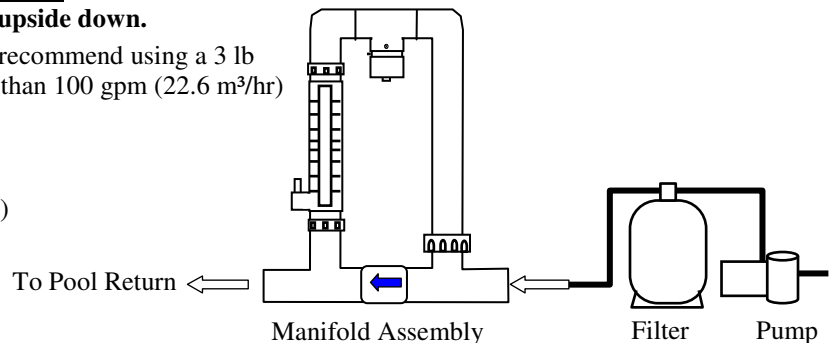

Verification of Flow Switch Protection:

It is important to verify the safe and proper operation of the Tri-sensor's Flow Switch protection device. We recommend the following procedure:

Using either a GOLF BALL or small plastic wrap (saran wrap, food wrap or zip lock bag), block off flow to the upper portion of the manifold. Place the golf ball in the strainer screen union or wrap the strainer screen with the plastic wrap and place it back in the union and tighten. Operating the system with this blockage should detect a LOW FLOW condition, indicated on the digital display and activate the "CHECK SYSTEM" light. Once verified, remove the plastic wrap or golf ball, replace the strainer screen and resume operation. If you do not get this result, turn the output dial to (0%) OFF and contact the factory.

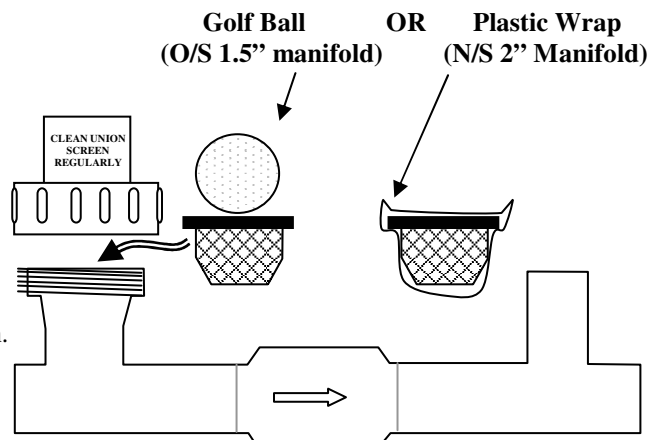

Section 3a – OPERATION

Key Features

The Pool Pilot™ *Digital* display will show the **PURIFYING OUTPUT LEVEL** (in percent %), or whether the system is in **BOOST** or **SUPER-BOOST Mode** on the first line of the two line alphanumeric display. The second line will display the current **TIME** in either 12 or 24-hr mode, the **TEMPERATURE** in either Fahrenheit or Celsius, whether the cell is powered or not, shown as **ON** or **OFF** and **Polarity Direction**, shown as a “.” or blank. Easy touch pads allow for adjusting and programming the unit. A **Check System** visual indicator works in conjunction with the display to advise of any problems.

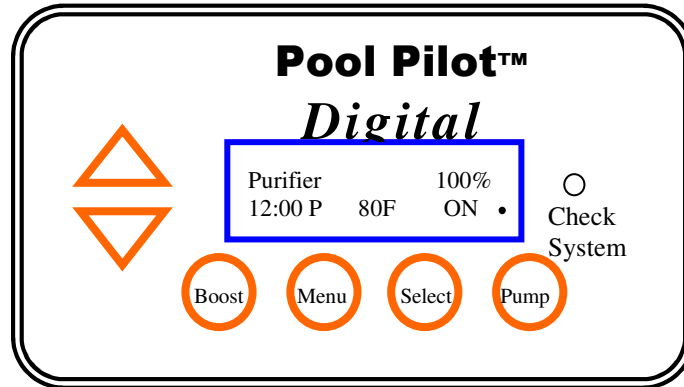

The **PURIFYING OUTPUT LEVEL** is adjustable from 0% (OFF) to 100 % (MAX) by pressing the **Up/Down Arrow** to obtain the desired Purifying Output Level and corresponds to the amount of time the cell is energized during a 15-minute cycle. The Display will switch between ON and OFF on the lower right corner to indicate if the cell is generating (ON) or in rest mode (OFF), depending on the Purifier % setting. Little adjustment is needed once the initial setting is established. See page 10 for further details.

Note: The Pool Pilot™ *Digital* does not test for purifier levels nor automatically adjust to maintain a desired purifier level. This is done by periodically testing the water and adjusting the output levels up or down, as needed.

The Pool Pilot™ *Digital* is designed with an **AUTOMATIC TEMPERATURE COMPENSATION feature**, which automatically adjusts the output level setting based upon changes in seasonal water temperatures, between 50°F to 90°F (10°C to 32.2°C) . This unique feature conveniently compensates for warm (more purifier needed) or cold (less purifier needed) water conditions. The Purifier % display will change automatically when temperature compensated and is considered normal.

The **BOOST Button** increases the purifier output level from the normal daily setting to 100% for up to 72 hours, and then returns to the normal setting. The purifying agent is continually produced throughout the normal On/Off cycles of the pump and throughout all power line disturbances until the end of the boost cycle or is manually deactivated. When Boost is activated with **External Timer** setting programmed, the time remaining for the boost cycle is held in memory and will start up in Boost mode until expired. With **One-Speed Pump** or **Two-Speed Pump** setting programmed, the time clock will be over ridden, producing purifier until the end of the boost cycle. The display will indicate the **BOOST Mode** on the second line when the boost button is pressed once. Once activated, the system will produce the purifying agent for 24 hours. The purifying agent can be produced for 72 hours by pressing and holding down the Boost Button for 5-seconds from the Boost-Off position. This is called the **SUPERBOOST Mode**. The display will indicate that the system has successfully entered the Super Boost mode. To discontinue operation of Boost mode or Super Boost mode, pressed the Boost Button once more.

The **Menu** and **Select Buttons** allows you to view the TEST mode, Program the Functions and Time Clocks. See the following pages for description of the menu tree.

* The **PUMP Button** allows you to over ride the pump timer to temporarily turn the pump on or off (depending on its status of operation), or to manually turn the pump off, indicated by the display “OFF FOR MAINTENANCE”. In “OFF FOR MAINTENANCE” mode, the pump is prevented from restarting by the time clock and is only reactivated only by manually programming it to turn the pump back on. Not applicable with “EXTERNAL TIMER” selection.

The **CHECK SYSTEM** light will flash if there is a problem with the system. The nature of the problem will be indicated by the display through various error messages. See the Troubleshooting section, page 14, for repair solution.

FREEZE PROTECTION: this protective feature allows the pump, when programmed for One-Speed Pump, to override the program cycle and run continually (30-minute minimum) when the water temperature falls below 40°F (4.4°C). This prevents any damage to the PVC due to water expanding as it freezes.

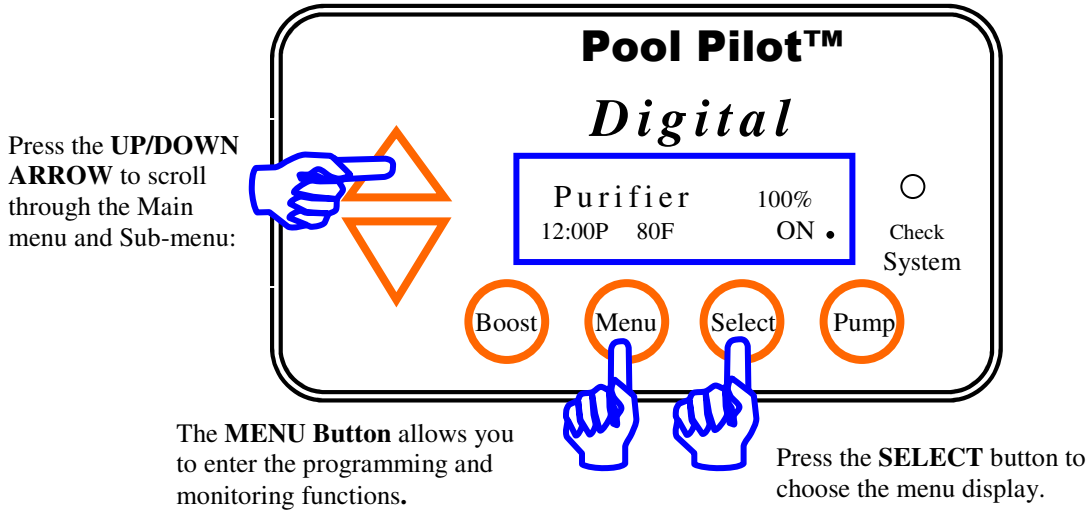

Main Menu

- 1.0 Test Pool Pilot for system diagnostics
- 2.0 Owner Options for pool owner to change display preferences, time of day and time clock on/off periods
- 3.0 Maintenance Menu for maintenance diagnostics, service procedures, and calibration
- 4.0 Installer Menu for installer and initial programming inputs
- 5.0 Exit Menu Mode returns to normal operation

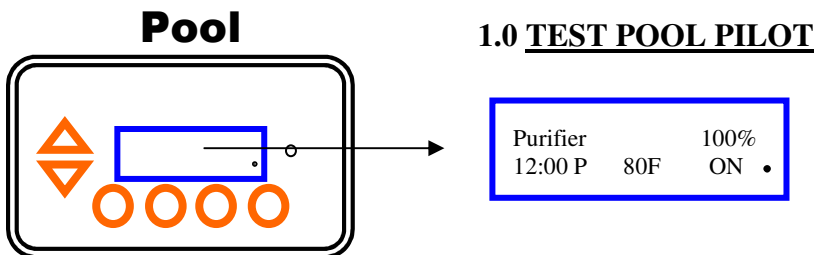

The display will automatically cycle through this program, then return to normal operation. The display shows as follows:

- 1.1 **Salt** in parts per million (PPM) or grams per liter (g/l)
- 1.2 **Add Salt** indicates the amount of salt needed to add to establish 3000 ppm (3,0 g/l) based upon pool volume
- 1.3 **Temperature** in Fahrenheit or Celsius
- 1.4 **Cell Volts and Amps**

2.0 OWNER OPTIONS

Use **UP/DOWN ARROW** to scroll through sub-menu and **SELECT** to choose function:

- 2.1 **English/Metric**: displays volume in gallons or cubic meters; salt additions in lbs or kg; **Back – Main Menu** (2.0)
- 2.2 **Temperature Units**: displays the water temperature in **Fahrenheit** or **Celsius**; **Back - Main Menu** (2.0)
- 2.3 **12/24-hour Time**: displays the current time in **12-hour Time** or **24-hour Time** units; **Back – Main Menu** (2.0)
- 2.4 **Set Time of Day**: sets the time as follows: **Set Hours**; **Set Minutes**
- 2.5 ***Pump Program 1**: allows you to program the pump on/off cycle through the on-board program
- 2.6 ***Pump Program 2**: allows you to program a secondary pump on/off cycle through the on-board program
- * Only applicable with **Pump Config.** (4.6) selection of **One-Speed Pump** or **Two-Speed Pump**
- * Pump Program 1 or 2 will show the previous time set. Otherwise, **Not Programmed** will display, then automatically step to display **▲ -Prog. ▼ -Delete SELECT-No Change**
- Selecting **▲ -Prog** steps to **Pump ON at Set Hours “12”:00 P; Pump ON at Set Mins 12:“00” P** then **Pump OFF at Set Hours “12”:00 P; Pump OFF at Set Mins 12:“00” P**
- 2.7 **Back – Main Menu** (returns to MAIN MENU)

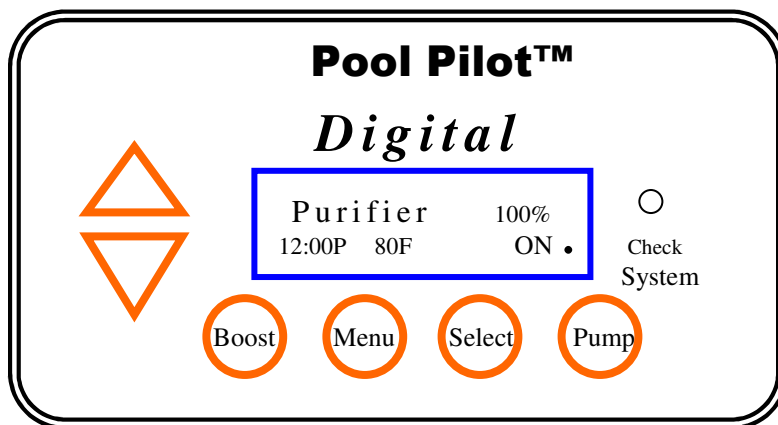

3.0 MAINTENANCE MENU

Use **UP/DOWN ARROW** to scroll through sub-menu and **SELECT** to choose function:

- 3.1 **Test:** same as 1.0 above plus cell **Amp-hrs** – then returns to Main Menu
- 3.2-3.4 **Set Time of Day:** same as 2.4 above
- 3.5 **Force Reverse:** allows you to check cell volts and amps in the opposite direction (verifies reversing feature)
- 3.6 **Set Reverse Time:** allows adjustable self-cleaning reverse rate of **2, 4, 8 or 16 hrs**; **Back – Main Menu** (3.0)
Cell reversal is set on 4-hrs from the factory for ideal cell life. For conditions such as high calcium levels that can cause the cell to scale quicker than the self-cleaning cycle can control, change the setting to “2” hours. For pools with optimum water chemistry balance according to the Saturation Index, see page 10, changing the REVERSING cycle to “8” or “16” hours will extend the life of the cell.
If the Reverse Time is set to the “16” hours setting, check the cell weekly for the first month to ensure no scale develops. If there is scale development, change the setting to “8” hours.
- Note:** changing the Reversing Time to “2” hours will affect the cell life. However, operating with scale development on the cell is more damaging to the life of the cell and changing the reversing time is suggested
- 3.7 **Calibrate Salt:** allow you to calibrate the salt display. Contact the factory for calibration solution
- 3.8 **Replace Cell:** zeros the amp-hour counter. Only used when replacing cells. Hold **Select** for 13 seconds to reset
- 3.9 **Back – Main Menu** (returns to MAIN MENU)

4.0 INSTALLER MENU

(Hold **Select** for approximately 13 seconds to enter this mode, indicated by the INSTALLER MENU text switching from the lower of the two line display, to the upper of the display)

Use **UP/DOWN ARROW** to scroll through sub-menu and **SELECT** to choose function:

- 4.1 **English/Metric:** displays volume in gallons or cubic meters; salt additions as lbs or kg; **Back – Main Menu** (4.0)
- 4.2 **Temperature Units:** displays the water temperature in **Fahrenheit** or **Celsius**; **Back - Main Menu** (4.0)
- 4.3 **12/24-hour Time:** displays the current time in **12-hour Time** or **24-hour Times** units; **Back – Main Menu** (4.0)
- 4.4 **Set Pool Volume:** displays the volume of the pool in either **Gallons** or **Cubic Meters**
- 4.5 **Set Cell Power:** allows you to set the **Power Level = 1, 2 or 3**; **Back – Main Menu** (4.0)
- 4.6 **Set Pump Config:** allows you to select from **External Timer, One-Speed Pump, Two-Speed Pump, or Remote Runs Pump** configuration
- 4.7- 4.9 **Set Time of Day:** same as 2.4 – 2.6 above
- 4.10 **Back – Main Menu** (returns to MAIN MENU)

Error Messages / “CHECK SYSTEM” light illuminated (see Troubleshooting section, page 15, for more details):

If the message “**Purifier Off**” is shown, the system halts purifier production. This is shown when the flow is insufficient. If the message “**Warning!**” is shown, the system will continue to produce purifier but at a reduced efficiency. This is associated with a correction message and flashing Check System light.

Section 3b – OPERATION

Pool Water Preparation

Salt Requirements

It is important that with typical pools, a salt residual of 2500 to 3500 ppm (2,5 – 3,5 g/l) be maintained at all times for peak efficiency. The Pool Pilot™ *Digital* can also handle special application salt levels of up to 35,000 ppm (35,0 g/l) without any adverse effects to the unit.

NOTE: HIGH Salt level does not affect purifier production but can cause corrosion problems with metallic fixtures, light rings, ladders and handrails. Maintain the salt level in the recommended range.

The amount of salt required depends on the size of the pool and the present salt level. As the salt is being added, we recommend running the circulation pump continually for 24 hours with the bottom main drain opened. Brushing the salt into the bottom main drain will assist in the dissolve rate and prevent possible staining with certain types of salt.

We recommend the use of **AutoSoft Plus™** Water Conditioning Salt. **AutoSoft Plus™** salt contains 99.8% pure Sodium Chloride (NaCl) without Iodine or the Anti-Caking additive, Yellow Prussiate of Soda (YPS). Iodine and YPS can cause a localized tint to the water or yellow staining on the cementitious finish if allowed to rest undissolved on the finish for extended periods of time. **AutoSoft Plus™** is blended with the proper amount of stabilizer to maintain a proper level within the recommended range when added according to the salt chart on the box.

Granular Salt, Table Salt, Solar Salt or Water Conditioner Pellets can also be used but will have different dissolve rates. If the salt you use contains Iodine or YPS, constant brushing will help the dissolve rate and prevent staining due to the additives in the salt. Ensure that the salt you use contain a minimum purity of 99% Sodium Chloride (NaCl).

NOTE: Do not use Rock Salt due to its high levels of impurities.

USE THE DIGITAL DISPLAY TO TEST YOUR WATER FOR SALT LEVEL FIRST, which then shows the amount of salt needed to achieve/maintain 3000-ppm. Salt readings below 100 ppm will show extremely high and requires the chart below to determine correct amount of salt needed.

SALT REQUIREMENT CHART

POUNDS (kg) OF SALT NEEDED FOR 3000 PPM RESIDUAL								
SALT Level Before Addition	Pool Volume in Gallons (m³)							
	1,000 (3.77)	2,500 (9.43)	5,000 (18.9)	7,000 (28.3)	10,000 (37.7)	15,000 (56.6)	20,000 (75.4)	30,000 (123.2)
0 ppm	25 (11.3)	63 (28)	126 (57)	175 (79)	252 (113)	378 (170)	504 (227)	756 (340)
500 ppm	21 (9.5)	53 (24)	106 (48)	147 (66)	212 (95)	318 (175)	424 (191)	636 (286)
750 ppm	19 (8.6)	48 (22)	96 (43)	133 (60)	192 (86)	288 (130)	384 (173)	576(259)
1000 ppm	17 (7.7)	43 (19)	86 (39)	119 (54)	172 (77)	258 (116)	344 (155)	516 (232)
1500 ppm	13 (5.9)	33 (15)	66 (30)	91 (41)	132 (59)	198 (89)	264 (119)	396 (178)
2000 ppm	8 (3.6)	21 (9.5)	42 (19)	56 (25)	84 (38)	126 (57)	168 (76)	252 (113)
2250 ppm	6 (2.7)	15 (7)	30 (14)	42 (19)	60 (28)	90 (41)	120 (54)	180 (81)

Note: The above chart is based on 1 lb. (2.2 kg) of salt added to 1,000 gallons (3.8 m³) to increase your salt residual 120-ppm.

Start Up Procedures

1. Balance your water chemistry according to the Water Chemistry Parameters shown above. Add the proper amount of salt (see Salt Requirement Chart) and circulate prior to starting your Pool Pilot™ *Digital*.
2. Set Purifier % setting to 50% and operate normally. For the first two weeks, test the water every 2-3 days for proper Purifier levels. Raise or Lower the Purifier % Setting as needed, according to your test results.
3. If Purifier % setting is 75% or higher, **INCREASE** the CELL POWER one level and reduce Purifier to 50% and readjust. If Purifier % setting is 25% or lower, **DECREASE** the CELL POWER one level and increase Purifier to 50% and readjust. (see instruction 4.5 on Pg 9)
4. Once your Purifier % Setting has been established, you will only need to adjust your level according to increased bather usage or heavy rainfalls that can quickly consume chlorine levels, or operate the Boost Cycle.

Section 3c – OPERATION

Monitoring and Maintenance

Water Chemistry Parameters - VERY IMPORTANT NOTE! Your Pool Pilot™ *Digital* is designed to provide Purifier on a daily basis. We recommend the following water chemistry ranges and periodic checks to monitor your systems efficiency. Always follow all local and state requirements.

Biweekly Checks:		Monthly Checks:	
Free Chlorine:	1.0 – 3.0 PPM	Calcium Hardness:	200 – 400 PPM
Or Bromine:	2.0 – 4.0 PPM	Total Alkalinity:	80 – 150 PPM
pH:	7.2 – 7.8	Cyanuric Acid:	60 – 80 PPM
		Salt Residual:	2500 – 3500 PPM
		Saturation Index:	± 0.3 pH of saturation
		Visual Cell Inspection	for wear, scale or debris

CHLORINE/BROMINE REQUIREMENTS: During Peak Purifier Demand (rainy season or heavy bather usage) it may be necessary to increase your purifier level by increasing your Output Level setting and/or pump run time. Conversely, during Low Purifier Demand, you can decrease your Output Level to a lower setting. For extremely Heavy Purifier Demand or to boost your purifier levels quickly, you can **Boost** the system or supplement with a Potassium Monopersulfate based shock.

NOTE: During cold-water conditions, below 60°F, Purifier demand is reduced significantly. For colder climate regions with sustained low or freezing temperatures, contact your local pool professional for proper pool winterizing instructions.

CAUTION: Excessive chlorine levels can cause premature cell failure, corrosion damage to stainless steel rails, ladders, heater heat exchangers, light faceplates and other metallic equipment. Avoid over saturation of chlorine levels.

pH: When your pH falls below the accepted range, your Purifier is used up very quickly and can be damaging to your equipment. For pH levels higher than the accepted range, your Purifier becomes much less effective and will work harder to keep your pool purified. Improper pH also contributes to the strong smell, red eyes, dry itchy skin and brittle hair conditions usually associated with “too much Chlorine”.

CALCIUM HARDNESS AND TOTAL ALKALINITY: Your Pool Pilot™ *Digital* provides 100% pure sodium hypochlorite and does not affect the calcium hardness or total alkalinity levels. Maintain and balance only as needed.

CYANURIC ACID (STABILIZER/CONDITIONER): This chemical goes by either trade name and allows your chlorine residual to last longer by protecting it from the UV degradation of the sun. With low or no Cyanuric acid it is possible for the chlorine being produced, to be used up as quickly as it enters the pool. Check and maintain your cyanuric acid levels at the same time as your salt level, as these tend to deplete at the same rate.

NOTE: For Bromine or indoor pools, it is not necessary to add stabilizer.

SALT RESIDUAL: Your Pool Pilot™ *Digital* works most efficiently with salt levels between 2500- 3500 ppm (2,5 – 3,5 g/l). If it falls below 2500 ppm (2,5 g/l), the Digital Display will show the proper amount of salt needed to maintain 3000 ppm (3,0 g/l). Low salt will cause premature deterioration of the Cell blades. For “SEAWATER” pools, your Pool Pilot™ *Digital* can handle up to 35,000 ppm (35,0 g/l), however, salt levels above 6000 ppm (6,0 g/l) can be corrosive to metallic fixtures.

CAUTION: Splash out water can leave a high salt concentration as the water evaporates. To prevent any potential salt damage, periodically hose off the deck, rails, and fixtures to dilute the salt concentration.

BROMINE RESIDUAL: Along with the normal Salt level, add 2lb (0.9 kg) Sodium Bromide (NaBr) per 2000 gallons (7.5 m³) of water. Your Pool Pilot™ *Digital* will now generate Bromine to purify your pool. Maintain your bromine level by checking your salt level. Once your salt falls below the recommended range, we suggest you add 2lb (0.9 kg) sodium bromide with every 50 lbs (22.5 kg) of salt added. We recommend testing Bromine Purifier levels with an OTO test kit.

SATURATION INDEX (Si): a formula used to ensure that your total water chemistry does not fall into a scale forming or corrosive condition. Either condition can cause premature damage to the Cell, equipment and cementitious finish. Have your water professionally tested periodically according to the Saturation Index or use this chart to determine your water balance.

$$Si = pH + TF + CF + AF - \text{Constant}$$

Temperature	TF	Calcium Hardness	CF	Total Alkalinity	AF	TDS	Constant
60F 15.6C	0.4	150	1.8	75	1.9	Below 1000	12.1
66F 18.9C	0.5	200	1.9	100	2.0	Above 1000	12.2
76F 24.4C	0.6	250	2.0	125	2.1		
84F 28.9C	0.7	300	2.1	150	2.2		
94F 34.4C	0.8	400	2.2	200	2.3		
103F 39.4C	0.9	600	2.4	250	2.4		

Test your water for pH, Calcium Hardness, Total Alkalinity and TDS levels. Use the equivalent Factor in the Si equation.

Si = ±0.3, balanced Si above + 0.3, scaling, staining or cloudy water conditions.

Si below -0.3, corrosive to metals, etches/deteriorates plaster finishes or skin irritating conditions.

Section 4a –SERVICE and MAINTENANCE

CONTROL BOX AND FUSE LOCATIONS

There are little serviceable parts on the Pool Pilot™ Digital Control Box except the fuses. For any other problems with the Control Box, please contact the Factory or Authorized Dealer/Service Center.

To remove the Control Box Cover and access the fuses, follow these steps.

⚠ DANGER: TURN OFF THE POWER FROM THE CIRCUIT BREAKER BEFORE SERVICING THIS UNIT.

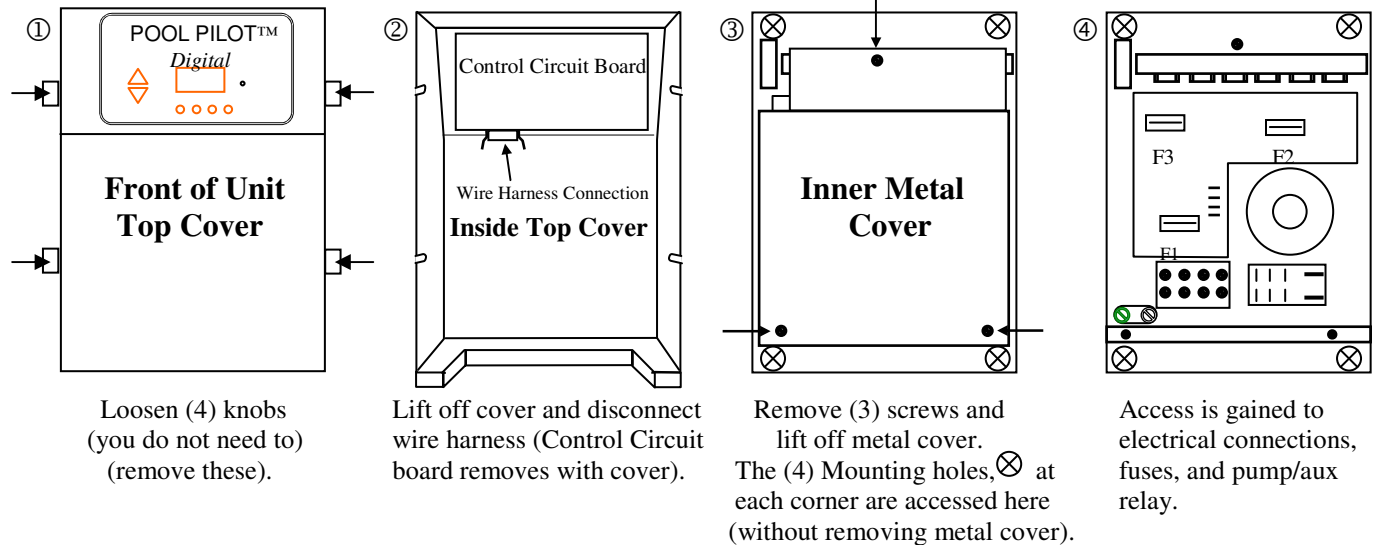

Fuse Location and Ratings

F1	Main AC Power Fuse	3 Amps 250 VAC (6 Amps @ 115 VAC)
F2	Control Panel Circuit Board Fuse	3 Amps 250 VAC
F3	Cell Fuse	20 Amps 250 VAC

TRI-SENSOR ASSEMBLY

The Tri-sensor assembly tests for Flow, Salt, and Water temperature. A minimum flow rate of 15 gpm (3.4 m³/hr) is required to activate the flow switch. As the water flow closes the paddle, a magnet activates a micro switch to verify proper flow. The Salt sensor protects against low salt levels, and the temperature sensor protects against cold water temperature operation and over chlorination when cold. Both of which can contribute to accelerated cell failure.

► **Note:** The use of high strength magnet devices in the close proximity of the tri-sensor can cause the flow switch to read incorrectly.

Remove the Tri-Sensor as follows (with pump off):

Remove both screws from the sides of the Tee Assembly. With the aid of large Channel-lok® (or similar) pliers, firmly grip the Tri-Sensor assembly and move back and forth while removing the Tri-Sensor from the tee. Inspect the thin metallic paddle for erosion and straightness. Take care not to twist or tweak this paddle, which can cause inaccurate flow readings. Inspect the salt sensor blades for scale and debris and clean if necessary. See page 13 for cleaning instructions. Follow the directions for Manual Cell Cleaning. Check the tri-sensor assembly for any damage to the plastic housing and replace if needed.

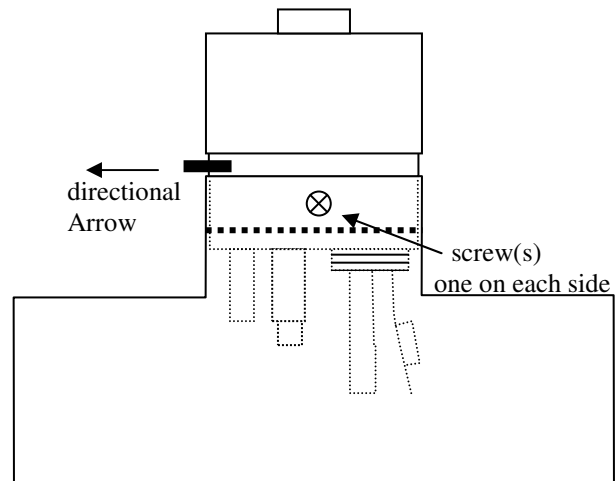

Section 4b –SERVICE and MAINTENANCE

Cell

The Cell is installed with Unions on each end of the cell to allow quick and easy removal. Loosen the unions and remove the cell from the plumbing.

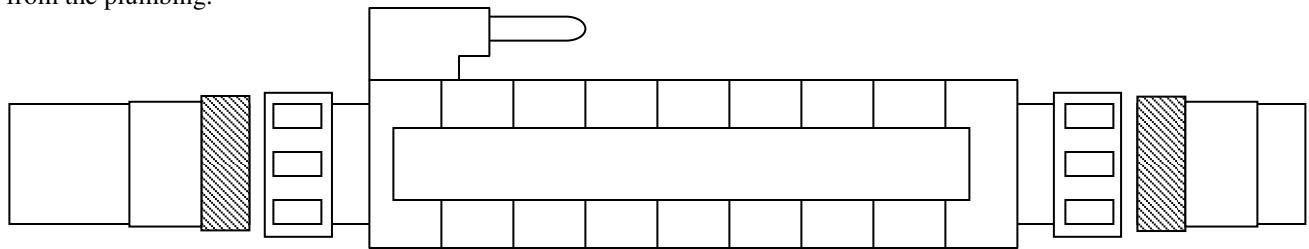

Side View of Cell and Unions

VISUAL CELL INSPECTION:

The titanium Cell blades, seen inside the Cell body, should be straight and clear of any debris between the blades. Your Pool Pilot™ *Digital* is designed to automatically self-clean calcium scale build-up within the Cell. However, imbalanced water chemistry and certain conditions can cause a heavier scale build up that exceeds the self-cleaning capability and would need to be cleaned manually by the method described below.

Periodically inspect both ends of the cell. A White Flaky or Crusty build-up on the edge or between the blades will prematurely deplete the life of the cell. Immediately clean the cell and determine the cause of scaling. See Troubleshooting Section, page 15.

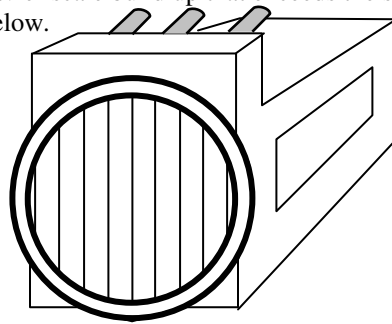

End View of cell
Looking at the Titanium Blades

MANUAL CELL CLEANING:

With the Cell removed as described above, use a high-pressure hose nozzle to spray off as much loose scale and debris as possible. Any remaining calcium scale can be treated with a mixture of one (1) part Muriatic Acid into four (4) parts water. Mix the solution in a container high enough to cover the Cell blades.

Remove the Cell cord and immerse the Cell so that the blades are completely covered in the solution for up to 15 minutes. An effervescences action indicates the calcium is being neutralized and cleaned. Drain the cell, flush with fresh water and re-inspect. Repeat the immersion if necessary.

We recommend using **Lo-Chlor Salt Cell Protector Plus** as a prevention additive to continually help soften and reduce build-up of calcium scale deposits in the cell. This product also reduces calcium scale on exposed aggregate finishes and new pool finishes and enhances chlorine production.

⚠ WARNING: ALWAYS ADD ACID TO WATER, never water to acid.

NEVER USE ANY SHARP OR METALLIC OBJECTS TO REMOVE SCALE. Scraping or scratching the titanium blade's edge or surface will allow chemical attack of the blade, cause premature failure of the Cell and will void your warranty.

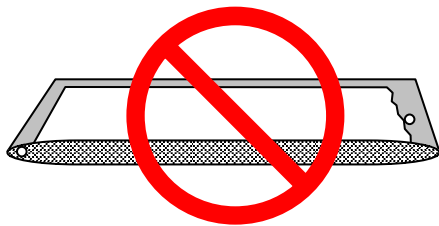

Hacksaw Blades

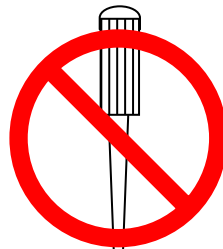

Screwdrivers

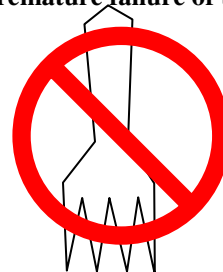

Forks

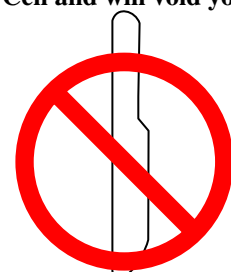

Knives

FILTER BACKWASHING:

We recommend turning the Control Panel Output setting to 0% (OFF) when backwashing a Sand or DE filter.

Section 4c –SERVICE and MAINTENANCE

Parts Explosion

Manifold Assembly:

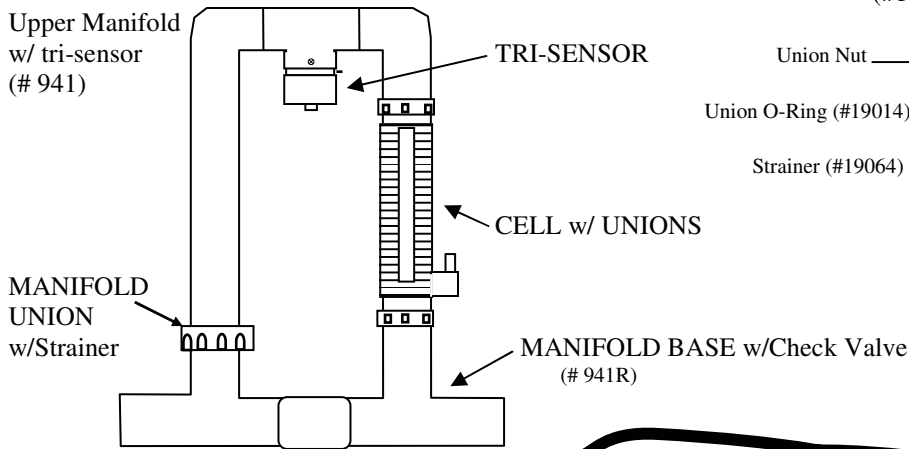

Manifold Union w/Strainer:

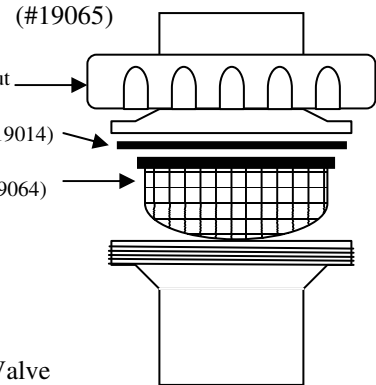

Electrolytic Cell:

(Cell Unions and Cord ordered separately)

Red Cap Plug for SC-36 and SC-48 cell cord (#19050)

12' (3.6m) Cell Cord (# 952-ST/DIG)

UNION COMPLETE (#19070)

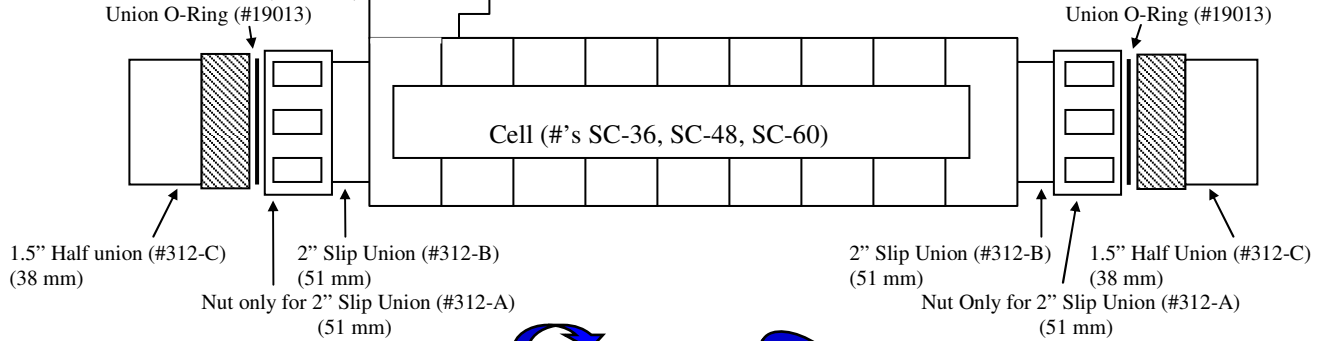

Tri-Sensor Assembly:

(Cord Ordered Separately)

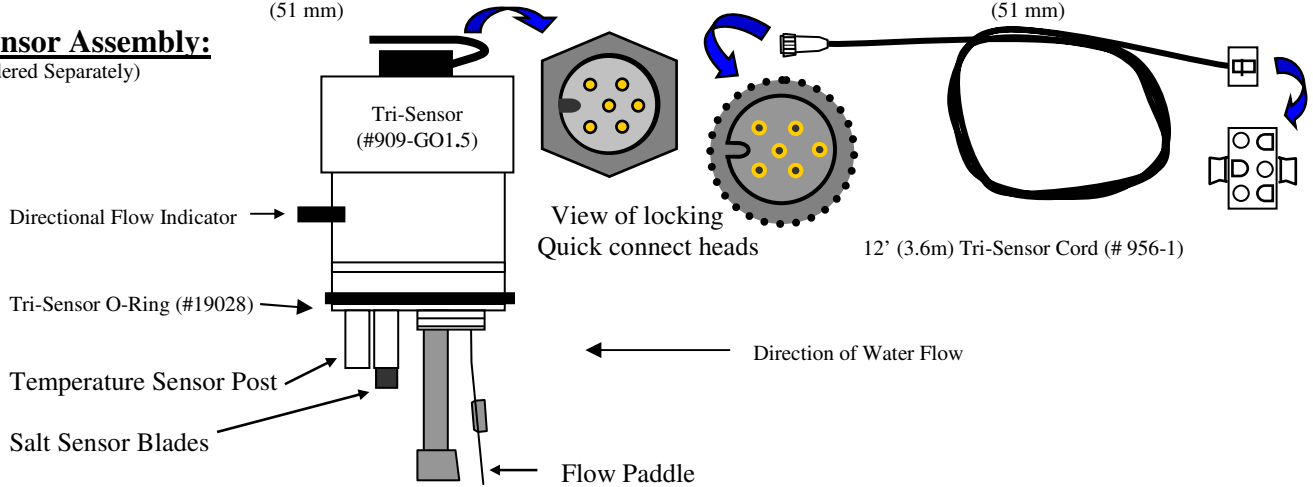

Section 5a – TROUBLESHOOTING

TRUBLESHOOTING

<u>PROBLEM</u>	<u>CAUSE</u>	<u>SOLUTION</u>
1) <u>Insufficient Purifier Production.</u>		
A) The test kit reagents or test strips are old or expired.	A) Retest with new Reagents or Strips.	
B) The unit is set too low in relation to purifier demand.	B) Increase the Purifier % output.	
C) The circulation run time is insufficient.	C) Increase your pump run time.	
D) The bather load has increased.	D) Same solution as (B) or add a Non-Chlorine Shock containing Potassium Monopersulfate to supplement.	
E) The body of water being purified leaks.	E) Repair the leak and rebalance as needed.	
F) Low Salt.	F) Check the residual salt level and adjust as needed.	
G) "Cell Type" selection not matched to the cell installed.	G) Follow the INSTALLER SETUP instructions, see page 9.	
H) Purifier loss due to intense sunlight	H) Check your stabilizer level and adjust if needed.	
2) <u>Scale Build-up within the Cell.</u>		
A) The water being purified contains high pH, total alkalinity and calcium hardness levels. (Cell scales within 2 – 3 weeks)	A) Calculate Langelier's Index to assure balanced water. Adjust chemicals and clean the Cell. See pages 13 & 14.	
B) Power Supply not reversing polarity. (Cell constantly scales within 3 – 5 days)	B) Contact the factory for Warranty Status/Procedures.	
3) <u>DC Plug and Cell Terminals Burned.</u>		
A) The Cell terminals are wet due to a leaking cell body.	A) Contact the factory for Warranty Status/Procedures.	
B) The Cell plug is not securely pushed onto the cell terminals, allowing moisture to seep into the plug.	B) Ensure the Cell cord plug is pressed completely onto the Cell terminal. Check the terminals and clean with a dry cloth to remove all dirt and corrosion.	
4) <u>Premature Cell Failure (Requires Replacement Cell).</u>		
A) Abnormally high Cell usage due to an insufficient Stabilizer (Cyanuric acid) level.	A) Check the stabilizer level and adjust to recommended levels.	
B) Excessive Scale/Debris in the Cell.	B) See Section 2 above.	
C) "Cell Type" selection not matched to the Cell installed.	C) Follow the INSTALLER SETUP instructions, see page 9.	
5) <u>White Flakes in the Water.</u>		
A) This occurs when excessive calcium hardness is present. Usually due to water chemistry imbalance.	A) Adjust your water chemistry, visually inspect Cell for scale build-up and clean the cell as described on pages 12 & 14.	
6) <u>No Power to the Control Box.</u>		
A) Internal Fuse blown.	A) Check and replace fuse. See page 12.	
B) Circuit Breaker tripped.	B) Check the power going to the Control Box. Reset the Circuit Breaker.	
7) <u>SERVICE Light Flashing.</u>		
MESSAGE DISPLAYED "PURIFIER OFF - CHECK FLOW" (No purifier generation during this display)		
A) Tri-Sensor Defective.	A) Contact the factory for Warranty Status/Procedures.	
B) Insufficient Flow (Min. 15 gpm) (3.4 m ³ /hr)	B) Ensure your Filter and Cell are clean of debris. Check all valves that might divert flow away from the cell.	
MESSAGE DISPLAYED "CHECK/CLEAN CELL" (Purifier still producing)		
A) Cell Volts	A) Check cell for calcium build-up or scale deposits. Water Temperature too cold (below 60°F (15.6°C))	
MESSAGE DISPLAYED "LOW AMPS – CELL" (Purifier still producing)		
A) Extremely Low Cell Amperage.	A) Cell heavily scaled. If cell is already clean, replace cell.	
B) Extremely Low Salt Level.	B) Salt level below 1500 ppm (1,5 g/l).	
C) The Cell Cord is Loose	C) Ensure that the cord is firmly pressed into the cell and the wires properly connected into the banana plugs.	
D) Power Supply has failed.	D) Contact the factory for Warranty Status/Procedures.	
MESSAGE DISPLAYED "LOW SALT - ADD XXX lbs (or kg)"		
A) Salt level Low (below 2500 ppm (2,5 g/l)).	A) Add the amount of salt shown on the display	
	B) Test the salt level with a reliable salt test kit and compare to the unit's display. Calibrate if needed, see page 9.	